

## STANDARD MAGNETIC PARTICLE LIQUID PENETRANT KIT

The **MT/PT Kit** contains:  
8 Plates and 2 Tees / Carbon Steel

Each specimen contains 2 "**REAL FLAWS**", randomly placed

Specimens are packaged in a **FREE CARRYING CASE**.  
Complete with Document Package with "Flaw Truth" documented  
by CAD drawings with a standard tolerance of +/- 0.150" (4mm).

The Standard MT/PT Kit contains 20 "real" flaws similar to those  
shown in the cross section drawings below.

**VISIT FLAWTECH WEBSITE OR CALL FOR PRICE INFORMATION**

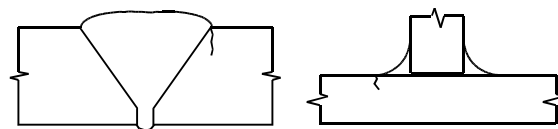

10. Toe Crack in Single Vee  
MT/PT, UT

11. Toe Crack in Fillet  
MT/PT, UT

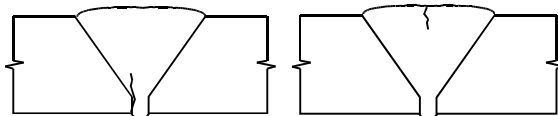

12. Root Crack in Single Vee  
MT/PT, UT, RT

14. Centerline Crack, Single Vee  
(surface breaking)  
MT/PT, UT, RT

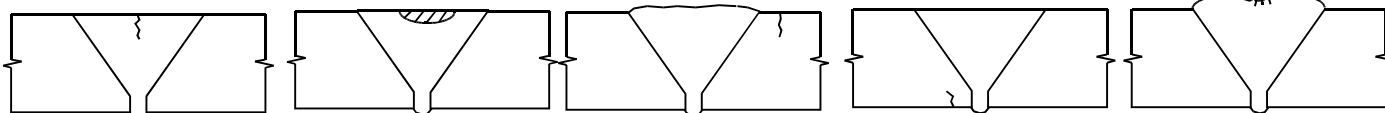

16. Circumferential Crack in  
Single Vee, flush crown  
MT/PT, UT

17. Transverse Crack in Single  
Vee, flush crown  
MT/PT, UT

18. Base Metal Crack in Single  
Vee (top HAZ area)  
MT/PT, UT

19. Base Metal Crack in Single  
Vee (bottom HAZ area)  
MT/PT, UT

20. Crater Crack in Single Vee  
(surface stop-start area)  
MT/PT, VT

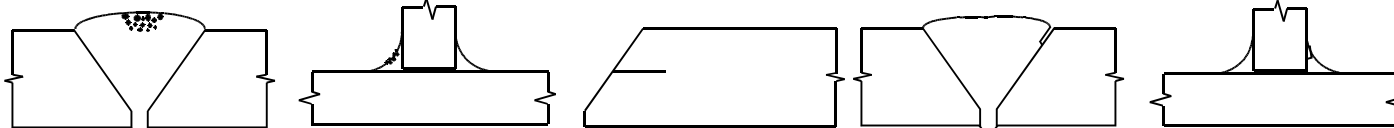

32. Porosity in Single Vee  
(surface breaking)  
VT, MT/PT

33. Porosity in Fillet  
(surface breaking)  
VT, MT/PT

51. Lamination in Weld Prep  
MT/PT

53. Lack of Fusion in Single Vee  
(surface breaking at crown)  
MT/PT, UT

54. Lack of Fusion in Fillet  
(surface breaking at crown)  
MT/PT

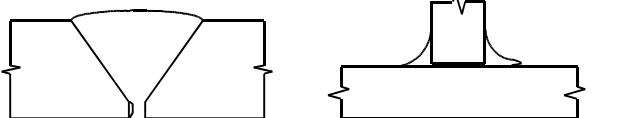

55. Lack of Fusion in Single Vee  
(surface breaking at root)  
MT/PT, UT

80. Overlap in Fillet  
VT, MT/PT

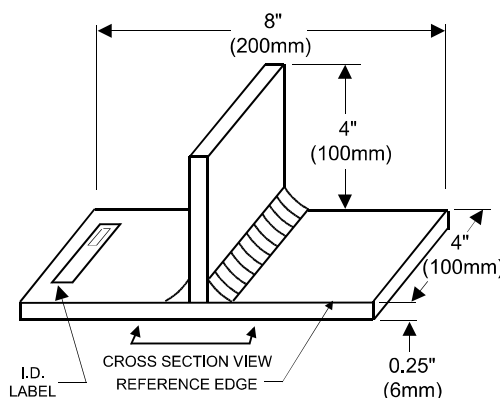
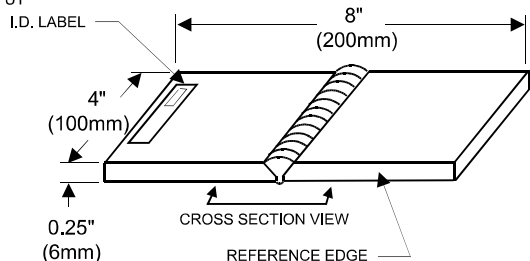

Drawings Not to Scale

Shipping Weight 35lbs

**ALL SPECIMENS CONTAIN  
"REAL FLAWS"**

**CONTACT YOUR LOCAL NDT  
SUPPLIER OR  
FLAWTECH FOR ORDERING DETAILS**